

# NOVIDADES 23



**MASTER / PROF**<sup>®</sup>  
PROFESSIONAL / TOOLS

## Broca Cilíndrica HSS Cabo Hexagonal Forma E

1/4" HEX FORMA E

HSS-G



1/4" HEX FORMA E

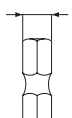

R ≤ 800 N/mm<sup>2</sup>

Aplicações



Metal



Aço



Lubrificante



Ø h8	l	L	Ø d	pcs.		€ Unidade
1,5	18	60	1/4	10	MBE100	1,10
2	24	69	1/4	10	MBE101	1,10
2,5	30	77	1/4	10	MBE102	1,14
3	33	81	1/4	10	MBE103	1,42
3,25	36	85	1/4	10	MBE104	1,52
3,5	39	90	1/4	10	MBE105	1,52
4	43	95	1/4	10	MBE106	1,66
4,25	43	95	1/4	10	MBE107	1,94
4,5	47	100	1/4	10	MBE108	1,94
5	52	106	1/4	10	MBE119	2,08
5,5	57	113	1/4	10	MBE110	2,52
6	57	113	1/4	10	MBE111	2,80
6,5	63	121	1/4	10	MBE112	3,74
7	69	109	1/4	10	MBE113	4,32
7,5	69	109	1/4	5	MBE114	5,58
8	75	117	1/4	5	MBE115	5,58
8,5	75	117	1/4	5	MBE116	6,94
9	81	125	1/4	5	MBE117	8,06
9,5	81	125	1/4	5	MBE118	8,88
10	87	133	1/4	5	MBE119	9,20

## Escareadores de 90° com cabo hexagonal de Forma E 1/4

HSS

1/4" HEX FORMA E

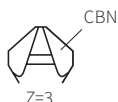

Z=3

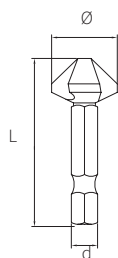

Aplicações



Metal



Aço



Ø	L	Ø d	para roscas DIN 74 BF	cod.	€ Unidade
6,3	40	1/4	M 3	ESCO80	7,58
8,3	45	1/4	M 4	ESCO81	8,95
10,4	47	1/4	M 5	ESCO82	10,80
12,4	49	1/4	M 6	ESCO83	11,62
16,5	52	1/4	M 8	ESCO84	13,68
20,5	55	1/4	M 10	ESCO85	18,84

## Fresa escalonada helicoidal cabo 1/4 Hexagonal Forma E

HSS-G



R ≤ 800 N/mm<sup>2</sup>

Ø min - max	Progressão Degraus mm	Nº Degraus mm	d mm	L mm	cod.	€ Unidade
4 a 12	1	5	1/4	80	MFE80	22,17
4 a 20	2	4	1/4	100	MFE81	25,36
6 a 30	2	4	1/4	98	MFE82	44,80



## JOGO DE FRESAS ESCALONADAS HELICOIDAIS HSS



**Caraterísticas:**  
Encaixe sextavado

**Composição:**  
3 fresas em caixa plástica:  
4 a 12mm  
4 a 20mm  
6 a 30mm



**36,25€**  
PROMO2329

## Fresa escalonada cabo 1/4 Hexagonal Forma E

HSS-G



R ≤ 800 N/mm<sup>2</sup>

Aplicações



Aço



Metal



Alumínio



Plástico



Lubrificante

Ø min - max	Progressão Degraus mm	Nº Degraus mm	d mm	L mm	cod.	€ Unidade
4 a 12	1	9	1/4	68	MFE90	17,86
4 a 20	2	9	1/4	78	MFE91	44,24
4 a 30	2	13	1/4	101	MFE92	53,84



Composição  
Gr.2 4 a 12 mm  
Gr.4 4 a 20 mm  
Gr.6 4 a 30 mm



**98,92€**  
MFE93

## Broca fura tudo alto rendimento cabo 1/4 Hexagonal Forma E

DIN 8039 ISO 5468

Universal - Fura tudo

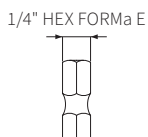

Ø mm	polegadas	d	l	L	pcs.	cod.	€ Unidade
3	1/8	1/4	45	90	1	MBE200	4,10
4	5/32	1/4	45	90	1	MBE201	4,12
5	3/16	1/4	50	100	1	MBE202	4,22
5,5	7/32	1/4	60	100	1	MBE203	4,54
6	15/64	1/4	60	100	1	MBE204	4,64
6	15/64	1/4	200	250	1	MBE205	8,40
6,5	1/4	1/4	200	250	1	MBE206	8,82
7	9/32	1/4	50	100	1	MBE207	5,68
8	5/16	1/4	50	100	1	MBE208	5,58
10	3/8	1/4	90	150	1	MBE209	8,16



4 pcs  
Ø 4 - 5 - 6 - 8 mm

**23,62€**

MBE210

## Broca para madeira 4 cortes com Cabo 1/4 Hexagonal Forma E

C.V.

Alto rendimento

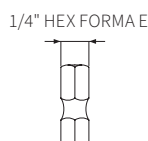

Ø mm	d	l	L	pcs.	cod.	€ Unidade
10	1/4	65	165	1	MBE300	9,68
12	1/4	65	165	1	MBE301	9,96
14	1/4	65	165	1	MBE302	12,00
16	1/4	65	165	1	MBE303	12,76
18	1/4	65	165	1	MBE304	13,86
20	1/4	65	165	1	MBE305	14,28
22	1/4	65	165	1	MBE306	16,02
24	1/4	65	165	1	MBE307	17,94
25	1/4	65	165	1	MBE308	19,74
26	1/4	65	165	1	MBE309	20,16
28	1/4	65	165	1	MBE310	21,44
30	1/4	65	165	1	MBE311	22,96
32	1/4	65	165	1	MBE312	23,94

Para furar madeira e derivados com alta eficiência.



6 pcs  
Ø 16 - 18 - 20  
22 - 25 - 32 mm

**116,44€**

MBE315

# STEP+

# 30%

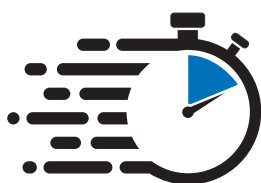

## mais rápida

Graças à geometria especial e ponta escalonada, a broca é 30% mais rápida que uma broca convencional.

# Alta durabilidade



Fabricado em aço HSS AISI M42 de alta qualidade que garante um alto desempenho constante e uma vida útil prolongada, mesmo em condições de uso intensivo.

# Prática, também em superfícies curvas

A ponta auto-centrante garante um furo fácil e perfeito, mesmo em superfícies curvas.

# STEP+

Broca helicoidal com ponta escalonada

# Furos perfeitos



Broca tradicional

Broca STEP+



# broca geometria especial com ponta escalonada

# Perfeita para

aço com  
 $R \leq 900 \text{ N/mm}^2$



**Broca Helicoidal com ponta escalonada**

**STEP+**

**HSS-G DIN 338**



Ø ≥ 3 mm



W 27°



< 5 d



R ≤ 900 N/mm<sup>2</sup>



Ø	l	L	n° degraus	pcs.	cod.	€ Unidade
1	12	34	-	10	MBPE01	1,16
1.5	18	40	-	10	MBPE02	1,16
2	24	49	-	10	MBPE03	1,16
2.5	30	57	-	10	MBPE04	1,18
3	33	61	1	10	MBPE05	1,26
3.2	36	65	1	10	MBPE06	1,62
3.5	39	70	1	10	MBPE07	1,48
4	43	75	1	10	MBPE08	1,62
4.2	43	75	2	10	MBPE09	1,86
4.5	47	80	2	10	MBPE10	1,94
4.8	52	86	2	10	MBPE11	1,75
5	52	86	2	10	MBPE12	2,11
5.2	52	86	2	10	MBPE13	2,87
5.5	57	93	3	10	MBPE14	2,66
6	57	93	3	10	MBPE15	2,84
6.5	63	101	3	10	MBPE16	3,34
7	69	109	4	10	MBPE17	3,91
7.5	69	109	4	5	MBPE18	4,18
8	75	117	5	5	MBPE19	5,15
8.5	75	117	5	5	MBPE20	5,57
9	81	125	5	5	MBPE21	6,37
9.5	81	125	6	5	MBPE22	6,98
10	87	133	6	5	MBPE23	8,02
10.5	87	133	7	5	MBPE24	8,69
11	94	142	7	5	MBPE28	9,8
11.5	94	142	8	5	MBPE29	10,65
12	101	151	8	5	MBPE30	12,23
12.5	101	151	8	5	MBPE31	13,11
13	101	151	8	5	MBPE32	14,02

L<sub>1</sub>



**Jogo 19 pcs**  
Ø 1 a 10  
Progressão 0,5 mm

**39,70€**  
PROMO2307



**Jogo 25 pcs**  
Ø 1 a 13  
Progressão 0,5 mm

**82,14€**  
PROMO2308

## Serra Craneana TCT Metal Duro Multimaterial

TCT

Uso intensivo - multimaterial



R ≤ 1200 N/mm<sup>2</sup>

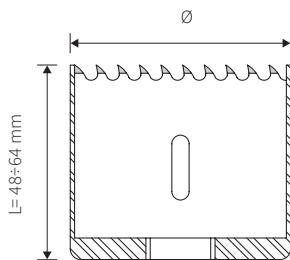

Ø mm	Ø polegadas	d rosca	cod.	€ Unidade
19	3/4	UNF 1/2 x 20	MVT01	13,2
22	7/8		MVT02	14,98
25	1"		MVT03	14,98
29	1-1/8		MVT04	16,86
32	1-1/4	UNF 5/8 x 18	MVT05	16,86
35	1-3/8		MVT06	16,86
38	1-1/2		MVT07	18,06
44	1-3/4		MVT09	18,96
51	2"		MVT10	20,48
57	2-1/4		MVT11	24,68
64	2-1/2		MVT12	24,68
68	2-23/32		MVT13	27,1
76	3"		MVT14	28,3
89	3-1/2		MVT15	33,86
108	4-1/4		MVT16	44,02



6 pcs  
Ø 19 - 22 - 29  
38 - 44 - 57

5519 - 5546

2 pcs  
Ø 7 x 100



**172,72€**  
MVT20



Mlock Adaptador para craneanas ultra rápido

# MLOCK

SISTEMA DE APERTO  
ULTRA RÁPIDO



**Adaptador Universal**  
1/2" X 20 UNF  
5/8" X 18 UNF  
Para todas as marcas de  
serras de 14 to 305 mm

**Cabo facetado**  
para máximo aperto na bucha



# MLOCK

## M-LOCK, KIT DE ADAPTADOR PARA SERRAS CRANEANAS



**13,40€**  
MVA300

kit de adaptador:

- 1 x adaptador M-LOCK
- 1 x broca L 95 mm
- 1 x broca L 100 mm
- 1x adaptador 1/2" X 20 UNF
- 1x adaptador 5/8" X 18 UNF

## ACESSÓRIO PARA ADAPTADOR M-LOCK



**19,44€**  
MVA301

Acessórios:

- 2x 1/2" x 20 UNF
- 3x 5/8" x 18 UNF



É a ferramenta mais fácil e intuitiva de usar.. é usada a seco, é auto-centrante.

## GRESMASTER

Broca para grês porcelânico

Para prolongar a sua vida útil, a broca deve ser usada para furar apenas o azulejo (1); ao entrar em contacto com a parede, se for necessário, deve-se instalar buchas de fixação (3); é aconselhável continuar o furo com uma broca de percussão rotativa normal para concreto (2).

A única precaução fundamental é **usar uma baixa rotação**, aproximadamente a 500 r.p.m..



A broca deve ser utilizada exclusivamente em **rotação**, sem o uso de percussão e tendo o cuidado de arrefecer entre os furos.

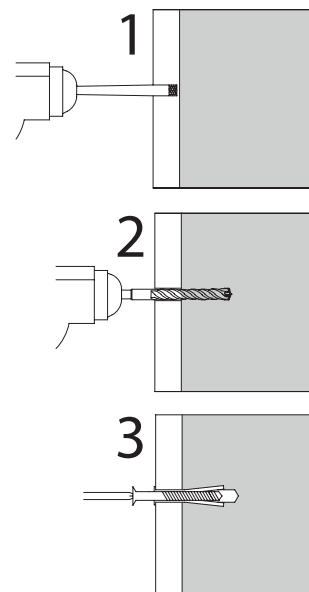

### Broca especial para grês porcelânico DIN 8039 ISO 5468

## GRESMASTER



Afiadura Especial



Ø	l	L	cod.	Unidade	€
4	85	50	MBG01		12,3
5	85	50	MBG02		13,26
6	100	65	MBG03		13,94
8	125	75	MBG04		17,48
10	150	90	MBG05		20,68



**VENTOSA DE PERFURAÇÃO**



7 Buracos  
Ø 4 - 5 - 6 - 7  
8 - 10 - 12 mm

**33,57€**  
MVG200

**VENTOSA GUIA REGULÁVEL**

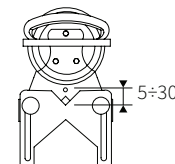
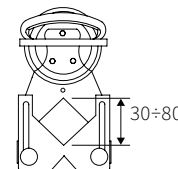

**59,50€**  
MVG201

**GARRAFA DE REFRIGERAÇÃO  
1 LITRO**



**21,00€**  
MVG202

**BROCAS DIAMANTADAS PARA GRÊS PORCELÂNICO COM ROSCA M14**

Código	Ø	L mm	Rosca	UN	€
MKG01	9	65	M14M	1	15,13
MKG02	8	65	M14M	1	16,75
MKG03	10	65	M14M	1	17,84
MKG04	12	65	M14M	1	18,92
MKG05	14	65	M14M	1	19,99
MKG06	20	65	M14M	1	23,78
MKG07	27	65	M14M	1	24,86
MKG08	30	65	M14M	1	25,94
MKG09	35	65	M14M	1	28,10
MKG10	40	65	M14M	1	32,43
MKG11	45	65	M14M	1	32,97
MKG12	50	65	M14M	1	37,29
MKG13	60	65	M14M	1	40,00
MKG14	65	65	M14M	1	42,69
MKG15	70	65	M14M	1	44,86
MKG16	75	65	M14M	1	45,94
MKG17	85	65	M14M	1	67,41
MKG18	100	65	M14M	1	76,94



**ADAPTADOR**

Código	Tipo	Cabo	Rosca	Chave	UN	€
MKG20	B1	Ø 12 mm	M14M	19	1	10,54
MKG21	W1	SDS+	M14M	19	1	30,40

# MASTERPRO

## Máquina com base magnética para fresas eletromagnéticas

Até Ø 32 mm, velocidade variável e inversão de rotação

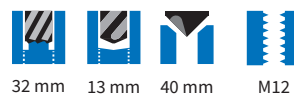

32 mm

13 mm

40 mm

M12



11 kg



1000 W



1500kg



150 mm



Velocidade variável



Inversão de rotação

### Capacidade de furação

Fresa Eletromagnética (Ø max)	12 - 32 mm
Broca helicoidal (Ø max)	1 - 13 mm
Escareador (Ø max)	10 - 40 mm
Macho de máquina (Ø)	M3 - M12

### Dimensões da máquina

Altura	370 - 512 mm
Comprimento	320 mm
Largura	210 mm
Curso	150 mm
Peso	11 Kg

Magnética (L x W x H) **160x80x42 mm**

Força Magnética **1500 Kg**

Potência do Motor **1000 W**

Voltagem **220-240 AC / 50-60 Hz**

Velocidade (sem carga) **100 - 600 rpm**

Velocidade (com carga 1000W, 9,1A) **225 rpm**

Encaixe **Weldon 19,05 mm**

**830,00€**  
EMAF2350

### Conteúdo da máquina

- 1x base magnética
- 1x proteção de segurança
- 3x cabos
- 3x adaptadores weldon para machos com cabo Ø 7,8,9
- 1x chave 2,5 mm
- 1x chave hexagonal 3 mm
- 1x chave hexagonal 4 mm
- 1x chave hexagonal 5 mm
- 1x sistema de lubrificação
- 1x corrente de segurança
- 1x manual de utilização
- 1x expulsor

MASTERPRO: Esquema de utilização dos acessórios



(incluído)

Adaptador de Macho de máquina com gambo Ø 7 mm

(incluído)

Adaptador de Macho de máquina com cabo Ø 8 mm

(incluído)

Adaptador de Macho de máquina com cabo Ø 9 mm



WELDON



Adaptador Weldon 19.05 Quick-in



Quick-IN



Adaptador Weldon 19.05 - 1/2 UNF



Bucha Encaixe 1/2 x 20 UNF



# MASTERELITE

## Máquina com base magnética para fresas eletromagnéticas

Até Ø 50 mm, *Duas velocidades*



**544,00€**

EMAF2351

### Capacidade de furação

Fresa Eletromagnética (Ø max)	12 - 50 mm
Broca helicoidal (Ø max)	1 - 20 mm
Escareador (Ø max)	10 - 50 mm

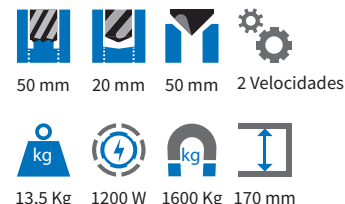

### Dimensão da máquina

Altura	385 - 550 mm
Comprimento	320 mm
Largura	210 mm
Curso	170 mm
Peso	13,5 Kg

Magnética (L x W x H)	168x84x49 mm
Força Magnética	1600 Kg
Potência do Motor	1200 W
Voltagem	220-240 AC / 50-60 Hz
Velocidade (sem carga)	380 rpm / 690 rpm
Velocidade (com carga)	235 rpm / 425 rpm
Encaixe	Weldon 19,05 mm

## MASTERELITE: Esquema de utilização dos acessórios

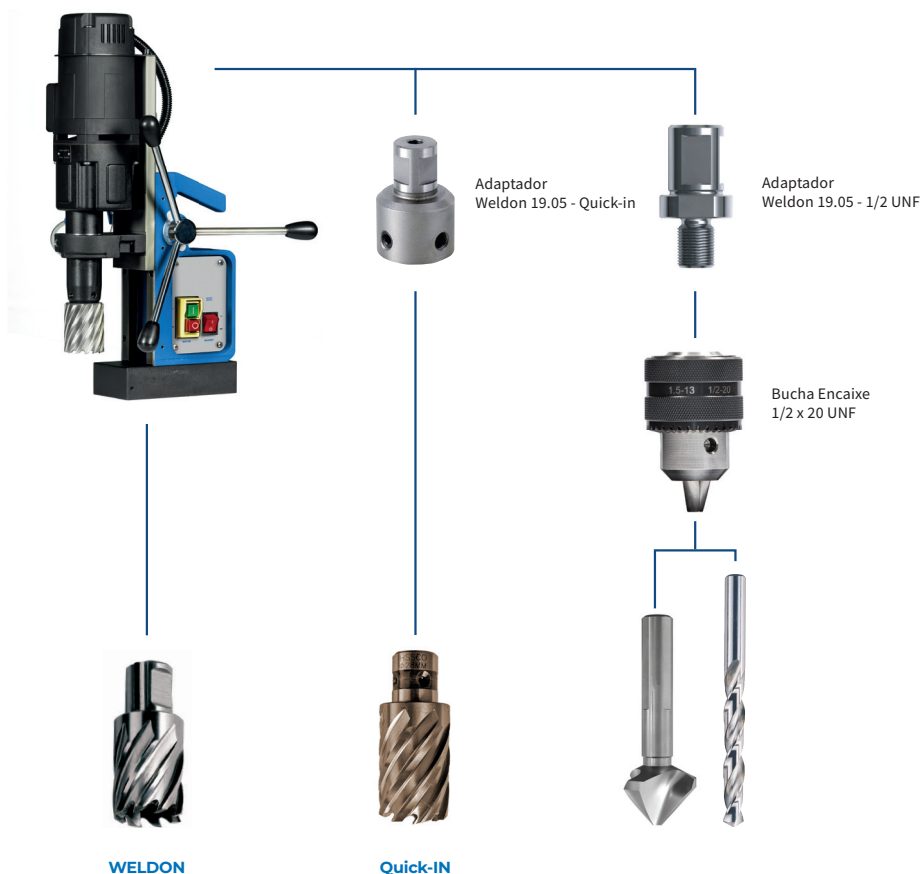

### Conteúdo da máquina

- 1 x base magnética
- 1 x proteção de segurança
- 3 x cabos
- 1 x chave hexagonal 2,5 mm
- 1 x chave hexagonal 3 mm
- 1 x chave hexagonal 4 mm
- 1 x chave hexagonal 5 mm
- 1 x sistema de lubrificação
- 1 x corrente de segurança
- 1 x manual de utilização
- 1 x expulsor

# MASTERBASIC

## Máquina com base magnética para fresas eletromagnéticas

Até Ø 35 mm



**362,00€**

EMAF2352

### Capacidade de furação

Fresa Eletromagnética (Ø max)	12 - 35 mm
Broca helicoidal (Ø max)	1 - 13 mm
Escareador (Ø max)	10 - 35 mm



35 mm 13 mm 35 mm



8,5 Kg 850 W 1000 Kg 90 mm

### Dimensão da máquina

Altura	293 - 383 mm
Comprimento	265 mm
Largura	175 mm
Curso	90 mm
Peso	8,5 Kg

Magnética (L x W x H)	160x81x36 mm
Força Magnética	1000 Kg
Potência do Motor	850 W
Voltagem	220-240 AC / 50-60 Hz
Velocidade (sem carga)	750 rpm
Velocidade (com carga)	400 rpm
Encaixe	Weldon 19,05 mm

## MASTERBASIC: Esquema de utilização dos acessórios



Adaptador Weldon 19.05 - Quick-in

### Conteúdo da máquina

- 1 x base magnética
- 1 x proteção de segurança
- 3 x cabos
- 1 x chave hexagonal 2,5 mm
- 1 x chave hexagonal 3 mm
- 1 x chave hexagonal 4 mm
- 1 x chave hexagonal 5 mm
- 1 x sistema de lubrificação
- 1 x corrente de segurança
- 1 x manual de utilização
- 1 x expulsor



WELDON



Quick-IN